

PIZZA PREP. TABLES



EPP - Series

MODELS: EPPR1
EPPSR2
EPPR2
EPPR3

Project / Customer _____

Item No. _____

Model No. _____



EPPR1



EPPSR2



EPPR2



EPPR3

Please visit our website for updated [Energy Efficiency](#) information.

Cabinet Construction

Heavy duty 430 stainless steel door, grill and side walls of exterior, and galvanized steel finished bottom and back wall of exterior. High quality 304 stainless steel interior, worktop, top lid, and hood. Insulated with 2.5" thick high density foamed-in-place polyurethane foam. Four 4" diameter casters (front casters with brakes). Door heater installed around inside cabinet frame to prevent moisture build up.

Refrigeration System

- Side mounted condensing unit
- Oversized condenser and evaporator coil cools to set temperature in a minimum time period and maintains it
- Forced-air cooling with oversized evaporator fan and motor providing balanced airflow throughout cabinet to ensure faster temperature pull down
- Removable side panel and slide-out condensing unit for convenient repair and maintenance
- Environmentally friendly CFC free R-134A refrigerant
- Air defrost, temperature initiated and terminated
- Copper tube and aluminum fin evaporator with anti-corrosive coating
- Energy efficient condensate drain pan assembly heated by high side copper tube
- Pressure relief port located at exterior back wall for rapid re-entry
- Pre-wired and ready to plug, 115V/60Hz/1Ph, NEMA 5-15P

Doors

- 430 stainless steel exterior with 304 stainless steel interior
- Insulated with 2.5" thick foamed-in-place polyurethane foam
- Rounded corners for a sleek and modern appearance
- Heavy duty adjustable torsion spring self-closing door system
- One piece snap-in magnetic door gasket for easy replacement
- Heavy duty recessed door handles that stay out of the way

Lighting

- Safety shielded incandescent interior lighting

Preparation Area

- 1/2" thick foam insulated lids to prevent moisture build up and heat exchange
- Removable and adjustable sanitary 19 1/4" deep cutting board
- Sanitary PVC pans

Shelving

- Two epoxy coated wire shelves per section
- 304 stainless steel pilasters and shelf clips

Temperature Control

- Factory preset temperature, 35°F
- Setting temperature range from 33°F to 41°F
- Easy to read digital temperature display
- Easy to control temperature by simply pushing buttons on control box
- Microchip digital monitoring system provided with various functions for monitoring and maintaining ideal temperature



Warranty

- 1 Year - Parts & Labor
- Extra 6 Months - Parts & Labor (when returning registration card)
- Additional 4 Years - Compressor

PIZZA PREP. TABLES



EPP - Series

DIMENSIONS

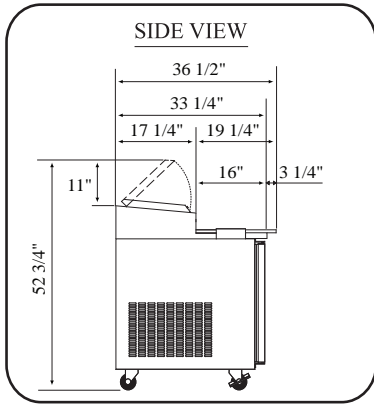

ALL UNITS

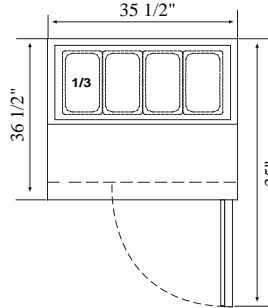

EPPR1

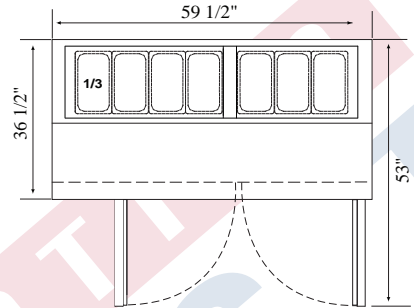

EPPSR2

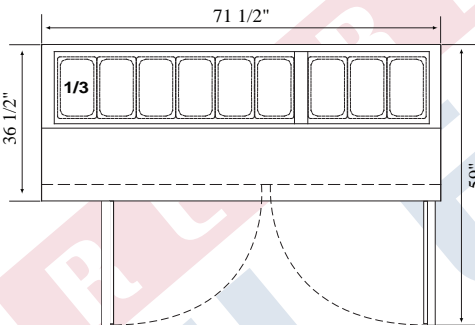
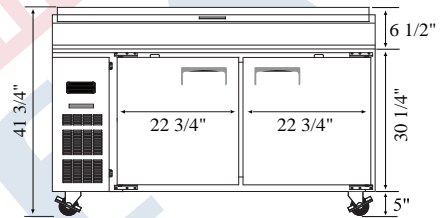
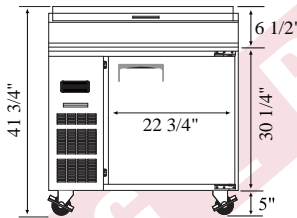

EPPR2

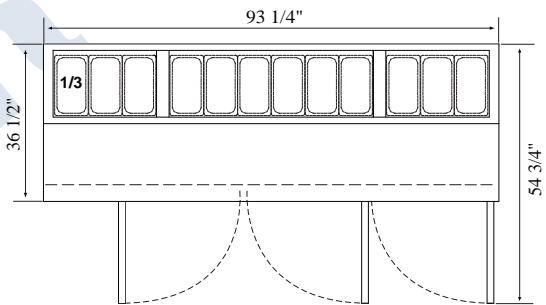

EPPR3

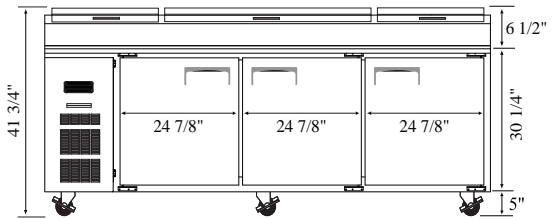
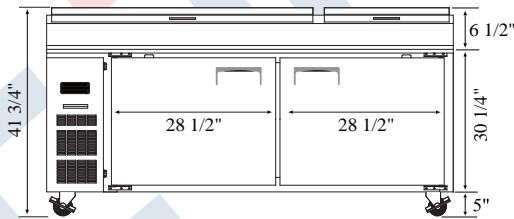

Model	Ref/ Fzr/ Dual	# of Doors	Capacity (Cu.Ft.)	HP	Refrigerant	# of Shelves	# of Pans	Power (V-Hz-Ph)	Amps	Crated Weight (LBS)	Exterior Dimensions (Inches)		
											L	D†	H*
EPPR1	Ref	1	9	1/5	R-134A	2	1/3 x 4	115-60-1	3.97	249	35 1/2	36 1/2	36 3/4
EPPSR2	Ref	2	15	1/3	R-134A	4	1/3 x 7	115-60-1	4.50	395	59 1/2	36 1/2	36 3/4
EPPR2	Ref	2	23	1/3	R-134A	4	1/3 x 9	115-60-1	6.30	458	71 1/2	36 1/2	36 3/4
EPPR3	Ref	3	30	1/3+	R-134A	6	1/3 x 12	115-60-1	9.20	610	93 1/4	36 1/2	36 3/4

* Height does not include 5" for caster.
† Depth includes 19 1/4" cutting board.